

dynakit

INSTRUCTIONS FOR ASSEMBLING THE DYNAKIT PREAMPLIFIER*

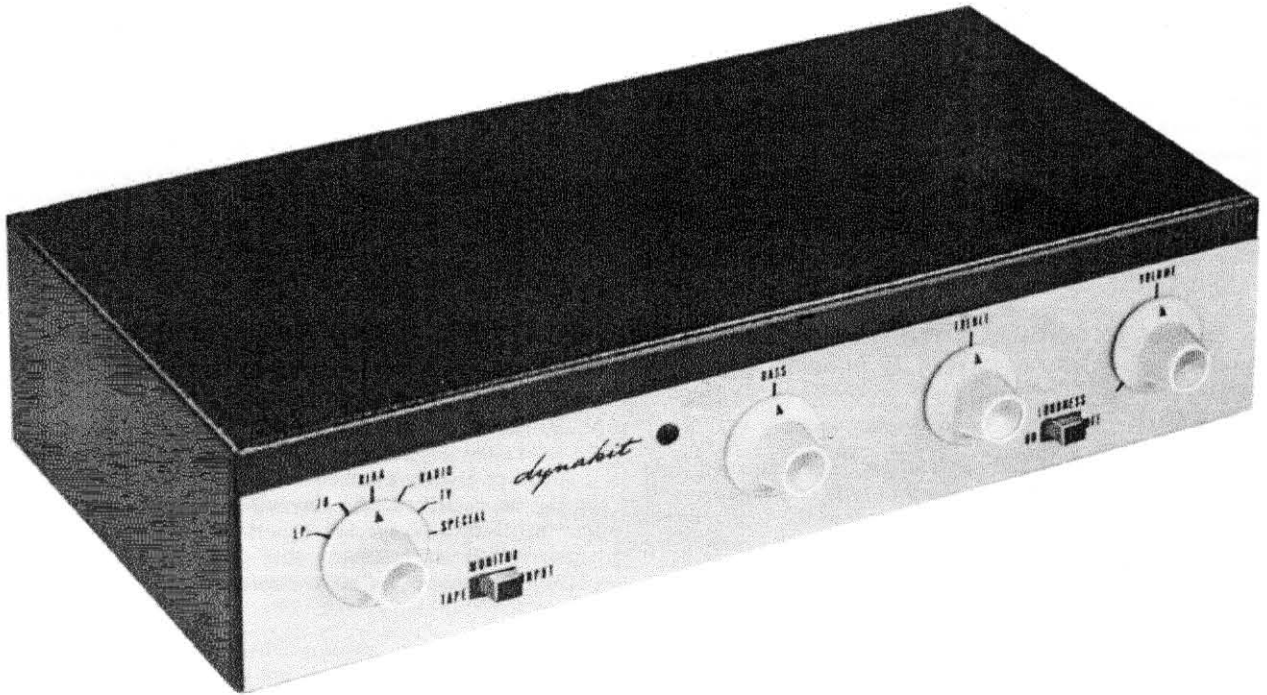

*U. S. PAT. PEND.

Price \$1.00

DYNA COMPANY

DYNACO

3916 POWELTON AVE.
PHILADELPHIA 4, PA.

Bob01605@aol.com

INSTRUCTIONS FOR ASSEMBLING THE DYNAKIT PREAMPLIFIER

DESCRIPTION

Your Dynakit preamplifier is a versatile preamplifier control unit which permits using any modern program source with your Dynakit or other power amplifier. This preamplifier uses a new circuit (patent pending) in which both voltage and current feedback loops include every tube section. These feedback loops give tremendous stability and consistency of performance, greatly reduced distortion, and exceptionally low noise.

The Dynakit preamplifier contains an unusual design arrangement. A single 12AX7 tube acting as a feedback pair with equalization determined by feedback at frequency extremes acts as a low level amplifier for magnetic cartridges, microphone, or tape head. This section has a voltage gain of 50 to bring up low level sources to a point comparable to inputs from high level sources such as radio tuners, tape recorders, etc. A second 12AX7, acting as a similar feedback pair, is the tone control section; and tone control action is adjusted by control of feedback at frequency extremes. This section has a voltage gain of 10 bringing the various inputs up to a high enough level to energize any popular power amplifier.

A volume control and switching system interconnects these two feedback pairs. By this type of arrangement, signals are attenuated before going into the tone control section so that there is no possibility of overloading regardless of the amplitude of the signal source. Therefore, distortion is unaffected by the position of the volume control. In many preamplifiers distortion is lowest with the volume wide open but rises significantly with the volume in the normal listening positions. This is not true with the Dynakit preamplifier.

The circuit arrangement used also eliminates frequency discrimination for different positions of the volume control. In much equipment on the market the high frequency response is lost when volume is reduced. This is not true in the Dynakit preamplifier where nothing is changed except the total gain by varying the volume control.

The Dynakit preamplifier is intended as a complete control unit so that there is no need to have the power amplifier in a convenient location. All switching of the audio circuits as well as control of the ac power to the auxiliary equipment is controlled from the preamplifier. A built in rectifier supply which converts the filament current to dc permits extremely quiet operation regardless of the power source to which the preamplifier is connected. These features make the Dynakit preamplifier completely independent of the type of circuitry from which it is powered.

GENERAL WIRING PRACTICE

Assembly of the Dynakit preamplifier is quite simple compared to general kit assembly requirements. This is true because all critical parts of the Dynakit are factory assembled for you on the printed circuit assembly. Other parts are put out in the open through a free and uncluttered layout so there is easy accessibility for wiring or trouble shooting purposes. Construction of your Dynakit should not take more than about six hours because of these simplifications.

Tools required for easy assembly of your Dynakit are soldering iron (small tip) or soldering gun, long nose pliers, screwdriver, and wire cutters. Although not essential, a low cost wire stripper and cutter of the type which can be purchased for less than \$1.00 will greatly facilitate cutting and stripping the various leads in the kit.

Good soldering technique is valuable in obtaining satisfactory results from any electronic equipment. **ALL SOLDERING MUST BE DONE WITH ROSIN CORE SOLDER.** There is no warranty on any equipment in which acid core solder has been used. Make sure that the solder used is plainly marked "Rosin Core." Whenever soldering is required, the assembly instructions specify it by "(S)." If this symbol is not shown after a connection is specified, it indicates that further connections will be made at that point before soldering.

Soldering is accomplished by heating the joint with the iron until solder is hot enough to flow when touched to the joint. It is not desirable to feed the solder to the iron. It should be fed to the junction of iron and joint. After the solder flows, the iron should be held in place for a few seconds and removed when it is seen that the solder has contacted both parts of the connection - the lug and the wire to which it is connected. It should not show a ball of solder but a smooth transition from solder to component lead.

Before applying solder the joint should be clean and the lead should be crimped in place so as to have mechanical security. It is not necessary to wrap leads around contacts many times. A single turn and pinching together with long nose pliers is suitable. After soldering, there should be no play at the joint if the lead is wiggled with a pair of pliers. It is practical to do all soldering with a pencil type iron of low wattage rating. A small tip is extremely useful when working in a confined space. If a soldering gun is used, it should be used with discretion since the amount of heat available is far more than required for soldering light wires.

Check the contents of the kit before assembly starts and identify the various parts as enumerated in the parts list at the end. Various pieces of hardware or controls are identified in the pictorial diagram. If you find shortages of any parts communicate with the dealer from whom you bought the kit, or with the factory directly in order to get immediate replacement of missing parts.

Note that both capacitors and resistors are cylindrical devices with wire leads. Resistors used in the Dynakit are invariably smaller than the capacitors and are color coded throughout. Where practical, the Dynakit capacitors are all stamped with the value. On the printed circuit board there are numerals alongside the various eyelets to which connections will be made. These are specified in the instructions as the points to which wires are carried.

The instructions which follow have been arranged for simplified procedure in which the work can be done without interference between the various portions of the wiring. It is recommended that the instructions be followed on a step by step basis, checking off each stage as it is completed. The pictorial diagrams should be used for reference and all connections checked against these before going on to the next stage. If the wiring is done methodically and each step checked carefully, your preamplifier should work without difficulty as soon as it is completed.

WIRING DIRECTIONS

- () 1. Mount input sockets in positions shown on pictorial diagram. The chassis under socket #1 must be scraped until the metal is bright so as to insure a proper ground contact with the metal body of the socket. These eight sockets should be mounted using #4 screws and nuts with a lockwasher under each nut. Note that there is a "hot" center terminal and a side ground lug on each socket. The positioning of the ground lugs should be the same as in the pictorial diagram, and the columns in which the ground contacts are adjacent will require slight forcing of the sockets which will bend the ground lugs slightly.
- () 2. The ac receptacles should be mounted on the rear flange of the chassis as shown in the pictorial diagram using #4 screws and nuts with a lockwasher under each nut.
- () 3. The bakelite capacitor mounting plate should be mounted on the rear of the back panel. Use #4 screws, nuts and lockwashers. The quadruple section capacitor should be mounted on this plate by pushing the tabs through the slots on the plate and giving each tab a 45 degree twist. The capacitor section marked with a semi-circle goes upright in the #1 position. (See pictorial diagram).
- () 4. Mount the two slide switches on the front panel, using #4 screws. Since there is a tapped hole for

mounting there is no need to use nuts and lockwashers. Note that the center lug of each switch should be closer to the chassis bottom than the two outer lugs.

- () 5. Mount the lug terminal strip using #4 screws, nuts, and lockwashers. Note that the two mounting tabs point toward the front of the chassis.
- () 6. Mount the 1000 ohm potentiometer (hum balance control) on the rear panel beneath the ac outlets. Put lockwasher over the shaft, push shaft through the hole, then screw on mounting nut and tighten. Note that the three terminals face toward the right hand edge of the chassis where they are clear of other parts and readily accessible for soldering. Do not let potentiometer touch the mounting hardware of adjacent ac receptacle #4.
- () 7. Insert four rubber feet by snapping into four corner holes in bottom of chassis. These are inserted by snapping in place from outside the chassis.
- () 8. Strip about five inches of hookup wire and cut into one inch lengths. Each of these is used as a link to connect adjacent lugs on the ac receptacles. The upper lugs are connected from receptacle #1 to receptacle #2, #2 (S) to #3, and #3 (S) to #4 (S). The lower row of lugs are connected from #1 to #2 and from #3 to #4 (S). There is no connection on the lower row from receptacle #2 to #3 as it is at these points that leads will be carried to the switch so that receptacles #3 and #4 can be switched from the front panel.
- () 9. Insert the 2" #6 screw through the chassis from below. Place a #6 lockwasher on the screw and a #6 nut. Tighten nut to hold the screw to the chassis.
- () 10. Take the two 1000 mfd capacitors and place side by side with the positive lead of one capacitor adjacent to the negative lead of the other. Place one on each side of the 2" screw with the positive lead of the outer capacitor toward the rear of the chassis. Place metal bracket over the capacitors with the screw through the hole in the bracket. Place selenium rectifier on top of the capacitor bracket with the #6 screw through the hole in the selenium rectifier. The positive side (red dot) of the rectifier should be up. The two terminals should point toward the rear of the chassis and the single terminal between the two plates (yellow dot) should point toward the center of the chassis. Secure with #6 lockwasher and nut (see pictorial diagram).
- () 11. The front leads of the two 1000 mfd capacitors should be brought to the #7 terminal on the lug terminal strip and crimped in place. Then connect

the positive capacitor lead at the rear to the positive rectifier terminal (red dot) and the negative lead of the adjacent capacitor to the other rectifier terminal (black dot). The leads should be put through the hole, crimped around in a single turn and the surplus wire cut off.

- () 12. Strip a three inch piece of hookup wire and cut into two 1-1/2" lengths. Connect the ground (side) lugs on the input sockets together as follows: lugs 1 and 2 connect to lugs 5 and 6 (S), lugs 3 and 4, connect to 7 and 8 (S). Strip the ends of a 2" piece of hookup wire and connect the junction of ground lugs 1 and 2 to the junction of lugs 3 and 4. Make sure that only the ground lugs are connected and that the center or "hot" sides are not touching the ground connections.
- () 13. Mount the 500,000 ohm potentiometer (volume control), the one which has a switch on the rear, in extreme right hand hole of the front panel. Put lockwasher next to control behind panel and use brass nut outside of chassis. The group of three terminals on the control should be upward as shown in the pictorial diagram.
- () 14. Cut two 8" pieces of wire and strip the ends. Twist together and connect one end of each of the pair to the lower lugs of ac receptacles #2 (S) and #3 (S). Connect pair of leads at the other end to the two rear lugs which are on the switch on the rear of the 500,000 ohm potentiometer (S). These wires should come straight back from the switch lugs until they reach the two 1000 mfd capacitors; then they should be brought down to the chassis around the outer edge of the capacitors. If they are too close to the components which later will connect to the potentiometer, they may introduce hum.
- () 15. Connect a 6-1/2" lead between input socket #7 (S) and the #1 lug on the tape monitor switch (S). Dress this lead close to the chassis bottom.
- () 16. Connect a 10-1/2" lead between #2 lug on the tape monitor switch (S) and #1 lug on the 500,000 ohm potentiometer. Dress this lead along the seam of the chassis.
- () 17. Mount the pilot light bracket using a #4 screw, nut, and lockwasher. Set the bracket so that when the bulb is inserted in the socket it will be directly behind the front panel hole where the pilot light indicator will be located.
- () 18. Cut a 6" wire and a 7" wire, strip the ends and connect one end of each to the two lugs on the pilot light socket (S). Twist these two wires together and connect the other end of one to lug terminal #7 and the other to the side lug (yellow dot) on the selenium rectifier. This pair of leads should be dressed close to the chassis.
- () 19. Mount the bass control potentiometer (750,000 ohms) in the position just to the right of the pilot light hole using a lockwasher next to the control and mounting nut outside the chassis.
- () 20. Mount the treble control (400,000 ohms) in the second mounting hole from the right side using the same mounting method as on the other controls.
- () 21. Connect .0075 mfd capacitor from #1 lug on the bass control to lug terminal #1.
- () 22. Connect 2-3/4" wire from the #2 lug on the bass control (S) to lug terminal #1.
- () 23. Connect .0075 mfd capacitor from #3 lug on the bass control to lug terminal #1.
- () 24. Connect a 62,000 ohm (blue-red-orange) and a 510,000 ohm (green-brown-yellow) resistor in parallel between lug terminals #2 and #3.
- () 25. Connect .02 mfd capacitor from lug #1 of treble control (S) to lug terminal #3.
- () 26. Connect 33 mmfd capacitor and 47,000 ohm (yellow-purple-orange) resistor in parallel between lug terminals #4 and #5.
- () 27. Connect .002 mfd capacitor from treble control lug #3 (S) to lug terminal #5.
- () 28. Connect 1000 ohm (brown-black-red) resistor from treble control lug #2 (S) to lug terminal #4.
- () 29. Connect 3-1/2" wire from bass control lug #3 (S) to lug terminal #5 (S).
- () 30. Connect .5 mfd capacitor from lug terminal #3 to lug terminal #6.
- () 31. The printed circuit board is mounted next using four #4 screws and nuts with a lockwasher under each nut. This board mounts on the inner flanges of the back panel with the components facing toward the rear of the chassis. The screws are inserted from the back of the chassis. Proper orientation of the board is when the numerals are right side up. Make sure that bottom edge of board is flush against inside of chassis.

In making solder connections to the printed circuit board, all connections are made to the numbered eyelets in the board. In this way, there is no danger of damaging the printed wiring or the components which are part of the board assembly. These eyelets already have solder in them and it is very easy to make solder connections to the board. The lead wires should have their ends stripped back about 1/4", and these stripped ends should be tinned by heating with a soldering iron and touching against the solder. When the wire is to be soldered to the eyelet on the board, the

eyelet is heated until the solder flows; and then the wire end is pushed into the eyelet and held in place until the solder sets. This type of soldering can be done with a very small iron, and it is preferable not to use any more heat on the eyelet on the board than is required to get the solder to flow.

- () 32. Connect 3-1/2" wire from lug terminal #1 (S) to eyelet #15 (S).
- () 33. Connect 2-1/2" wire from bass control lug #1 (S) to lug terminal #2.
- () 34. Connect .1 mfd capacitor from input socket #8 (S) to lug terminal #2 (S). Use sleeving over wire ends of this capacitor to prevent shorting against chassis or adjacent parts. The capacitor should be dressed flat against the chassis with the lead going to the input socket kept as far from other input sockets as possible.
- () 35. Connect 2-1/2" wire from eyelet #10 (S) to lug terminal #3.
- () 36. Connect 3" wire from eyelet #12 (S) to lug terminal #4 (S).
- () 37. Connect 3-1/4" wire from eyelet #11 (S) to condenser lug #4.
- () 38. Connect 2-3/4" wire from eyelet #16 (S) to condenser lug #3.
- () 39. Connect 10,000 ohm (brown-black-orange) resistor from condenser lug #4 (S) to condenser lug #1.
- () 40. Connect 100,000 ohm (brown-black-yellow) resistor from condenser lug #1 to condenser lug #2.
- () 41. Connect 4-1/4" wire from eyelet #7 (S) to condenser lug #1 (S).
- () 42. Connect 6-1/2" wire from eyelet #4 (S) to condenser lug #2 (S).
- () 43. Strip ends of two 6" wires. Fasten one end of each to eyelets #13 (S) and #14 (S). Twist these together and connect the other ends to the positive (red dot) and negative (black dot) terminals of the selenium rectifier.
- () 44. Connect two 2-1/2" wires from the positive and negative ends of the rectifier (solder both) to the two end lugs of the 1000 ohm hum balance potentiometer on the back panel (Solder both).
- () 45. Connect a 6" piece of wire between center lug on the hum balance potentiometer (S) to lug terminal #6 (S).
- () 46. Connect 3" wire from lower right hand mounting prong on capacitor can to lug terminal #3 (S).

You have now completed more than half of the work in your preamplifier and can proceed with the switch assembly and final connections.

SWITCH ASSEMBLY

Hold metal front plate of switch and rotate the shaft with pliers until it is fully counter clockwise. Note that there is a forward deck and a rear deck, each with 12 lugs. A red dot identifies the #1 lug, and the remaining lugs on each deck are identified in clockwise sequence. On the front of the forward deck there is a split section on the rotating wafer. Hold the switch until this split section is at the upper left (10 and 11 o'clock position if the lugs of the switch deck are identified in clockwise fashion). Note that there are 12 lugs on the forward deck and 12 on the rear deck, even though some of these appear on the front of the deck and others on the back. These wiring instructions will not differentiate between two sides of a given deck but will always refer to the forward or rear decks with the numbers designated as on the basis of a clock.

- () 1. Connect 560,000 ohm (green-blue-yellow) resistor from lug #1 on the forward deck to lug #1 on the rear deck (S).
- () 2. Connect 1.5 megohm (brown-green-green) resistor from lug #3 on forward deck to lug #3 on rear deck.
- () 3. Connect 3200 mmfd (or pf) capacitor from lug #3 on forward deck to lug #4 on rear deck.
- () 4. Connect 1000 mmfd (or pf) capacitor from lug #7 on forward deck to lug #7 on rear deck (S).
- () 5. Connect 250 mmfd (or pf) capacitor from lug #8 on forward deck to lug #8 on rear deck (S).
- () 6. Connect 750 mmfd (or pf) capacitor from lug #9 on forward deck to lug #9 on rear deck.
- () 7. Connect short links of bare wire between lugs #7 and #8 on the forward deck and between #8 (S) and #9 on the forward deck.

At this point, you should decide whether the "special" input which is a feature of the Dynakit should be used for an extra magnetic cartridge or for a microphone or tape head input. Most people will prefer to have it as an extra RIAA phono input so that they can have a record changer connected as well as a turntable. In order to do this, it is only necessary to add two short links of wire on the rear switch deck. One link connects from lug #9 (S) to lug #12 (S) and the other from lug #3 (S) to lug #6 (S), both connections being made on the rear deck.

If the "special" input is to be used for a microphone, previous instructions for using it as an extra RIAA phono input should be ignored and the previous connections made to lugs #3 and #9 on the rear switch deck should be soldered. Then a wire should be connected from lug #6 on the forward deck to lug #6 (S) on the rear deck; and another wire from forward deck lug #3 to forward deck lug #6 (S). In addition, a 33 mmfd capacitor should be connected from rear deck lug #12 (S) to forward deck lug #12, and a link of wire connected from forward deck lug #12 (S) to lug #9 on the forward deck.

If the "special" input is to be used for tape head instead of using a tape head preamplifier in the tape playback equipment, previous instructions for using it as either an extra RIAA phono input or a microphone input should be ignored; and the previous connection made to lug #9 on the rear switch deck should be soldered. Then a 33 mmfd capacitor should be connected from rear deck lug #12 to forward deck lug #12. Then an 18,000 ohm (brown-gray-orange) half watt resistor should also be connected from rear deck lug #12 (S) to forward deck lug #12. Then a link of wire should be connected from forward deck lug #12 (S) to forward deck lug #9. Then a short link of wire should be connected from lug #3 (S) on the rear deck to lug #6 (S) on the rear deck. This hookup is not required to play back from a tape machine which has internal preamplification. It is used only for play back from a tape deck which contains no preamplifier. The equalization obtained from this set of connections is the NARTB standard playback equalization.

Naturally, it is possible to convert from one of the optional uses to any of the others at any time. However, the instructions are shown at this point since it is less effort to incorporate the connections before the switch is mounted than after it has been installed.

- () 8. Strip ends of a 5-1/2" wire and fasten one end to lug #7 on the forward deck (S). Leave the other end hang, later it will go to eyelet #6 on the printed circuit board.
- () 9. Connect a short jumper from #1 lug on forward deck to #3 lug (S). Make sure that the bare wires do not touch any other portions of the switch.
- () 10. Strip ends of a 3-1/4" wire and connect to lug #1 on forward deck (S). The other end of this wire will go to eyelet #1 on the printed circuit board after the switch is mounted.
- () 11. Strip ends and connect a 3" wire from lug #4 (S) on rear deck. Leave the other end hanging which will go to eyelet #5 on the printed circuit board.
- () 12. Strip ends and connect a 1-1/2" wire to lug #5 on the forward deck. The other end of this wire will later go to lug #3 on the tape monitor switch.
- () 13. Cut two 7" wires. Strip ends. Connect one end of each wire to lugs #4 and #5 on forward deck. (Solder both). Put a kink at the other end of the lead from lug #4 so as to identify this as a ground connection later. Then dress the leads toward the rear of the switch and twist together.
- () 14. Mount the switch using a lockwasher between switch frame and panel. Tighten mounting nut tightly after orienting switch. The #1 and #12 lugs should be at the top.
- () 15. Connect the kinked wire of the twisted pair to the ground junction of #3 and #4 input sockets (S). Connect the other end of the pair (which comes from #5 on the forward deck of the switch) to "hot" center lug of #4 input socket (S). Dress these leads along bottom of chassis.
- () 16. Connect the hanging wire from #5 lug on forward deck to #3 lug on the tape monitor switch (S).
- () 17. Connect a .1 capacitor from #9 lug on forward deck (S) to #2 lug on forward deck (S). This capacitor goes over the switch, resting horizontally against the switch frame with the leads swinging clear of the unused lugs.
- () 18. Connect the hanging lead from #4 on the rear deck to eyelet #5 (S).
- () 19. Connect the hanging lead from lug #7 on the forward deck to eyelet #6 (S).
- () 20. Connect 7" wire from input socket #6 (S) to lug #10 on forward deck. Pass this wire through the pair of lugs at this position (both front and back of wafer) and solder. Dress wire against chassis bottom.
- () 21. Connect 8" wire from input socket #3 (S) to pair of lugs at #11 on forward deck (S). Dress this lead against bottom of chassis.
- () 22. Connect a 56,000 ohm (green-blue-orange) resistor from input socket #5 to rear deck switch lug #10.
- () 23. Connect 330,000 ohm (orange-orange-yellow) resistor from input socket #1 to input socket #5 (S).

These last two connections determine a 50,000 ohm termination for both high and low level phono inputs, and 56,000 ohms for "special" input. If "special" input is used for magnetic cartridge, this value will be correct. If a low impedance microphone (with matching transformer) or tape head is used in "special" input, the termination will also be correct. A high impedance microphone like the B&O 53 can be used directly without need for a matching transformer if the "special" input is connected for microphone.

The terminations on the two phono inputs will handle practically all cartridges. However, if a lower impedance is desired, it can be obtained by adding resistance directly across the cartridge terminals. For example, 56,000 ohm resistor across the cartridge will make the total load on the cartridge about 27,000 ohms which is the suggested termination for older models of Pickering cartridges. If a 100,000 ohm termination is required for low level phono input, it can be obtained by changing the 56,000 ohm resistor on the printed circuit board to 120,000 ohms.

- () 24. Connect a 3-1/4" wire from input socket #2 (S) to rear deck lug #5 (S) on switch.
- () 25. Connect 3-1/4" wire from input socket #1 (S) to rear deck lug #2 (S) on switch.
- () 26. Connect 2-1/2" wire from rear deck lug #10 to eyelet #3 (S) on printed circuit board.
- () 27. Connect 2-1/4" wire from rear deck lug #11 (S) to eyelet #2 (S).
- () 28. Connect 3-1/4" wire from ground junction of input sockets #1 and #2 (S) to rear deck lug #10 (S) on switch.
- () 29. Connect hanging wire from forward switch deck lug #1 to eyelet #1 (S).
- () 30. Connect .05 capacitor from #4 lug on volume control to #3 lug on loudness switch. This capacitor goes under the control close to the chassis. The leads should be kept clear of the wires which go to the switch on the rear of the volume control.
- () 31. Connect 2-1/2" wire from #4 lug on volume control (S) to #2 lug on loudness switch (S).
- () 32. Connect 10,000 ohm (brown-black-orange) resistor from #3 lug on loudness switch (S) to #3 lug on volume control. Swing body of resistor over control so no part of the leads touch the control. Use sleeving on the bare leads if necessary.
- () 33. Cut lead on 470,000 ohm (yellow-purple-yellow) resistor until it is about 3/8" long, and bend a hook in this end. Do the same with 100 mmfd capacitor. Crimp the two hooks together and solder so that the capacitor and resistor are joined together with only a short lead between them. Connect the free lead of this capacitor to #1 lug on the loudness switch (S). Connect the free end of the resistor to lug #1 on the volume control (S).
- () 34. Take two 8" wires, fasten one to eyelet #8 (S) on the printed circuit board and the other to eyelet #9 (S) on the printed circuit board. Kink the

end of the one which fastens to eyelet #9 so as to identify it after twisting. Twist together and carry across the top of the chassis (where it will lie against the cover when the cover is closed). The wire with the kink goes to volume control lug #3 (S) and the other wire goes to lug #2 (S) on this control.

- () 35. Take the 4 conductor cable. Strip the outer jacket back two inches and strip the end of each lead back about 1/4". Insert rubber grommets in the two holes adjacent to the hum balance control (below the ac receptacles). Insert the stripped end of the cable from outside the chassis through the #1 grommet hole until it is inside chassis. Tie a figure 8 knot in the cable about two inches behind the stripped section and pull cable back until the knot pulls tight against the back panel.
- () 36. Connect the black wire to capacitor mounting prong to which wire from lug terminal #3 was previously connected (S).
- () 37. Connect the red wire to capacitor lug #3 (S).
- () 38. Connect the white wire to lug terminal #7 (S).
- () 39. Connect the green wire to side lug (yellow dot) of selenium rectifier (S).
- () 40. Slide the cap over the free end of the cable. Strip the outer jacket of the cable back 1-3/4". Strip each wire about 3/4". Each of the wires should be tinned by heating it with a soldering iron and applying a very thin coat of solder. This will make it easier to solder these wires when they are inserted in the pins of the plug. It is easier to solder to the pins of the plug if the tip of each pin is reamed lightly by inserting the point of a knife or file and rotating it so as to scrape the plating on the pin.
- () 41. Insert the white wire into the #1 pin on the octal plug. Insert the green wire in the #2 pin, the black wire in the #3, the red in the #5, until the ends of all these wires protrude. Hold the soldering iron against the tip of each prong in turn and feed solder to the hole where the wire protrudes until the solder runs freely into the hole. Do not get solder on the sides of the prong or you will have to file it off in order for the prong to be able to plug into the socket. After soldering, trim excess length of wires which protrude, using wire cutters.
- () 42. Strip 2-1/2" of wire and bend it in a close U. Insert this through pins #6 and #7 on the octal plug, thus making a link between these. Solder these wires as was done with the wires in the cable, and trim off the excess wire. Then snap the cap on to the socket.

- () 43. Insert the cut end of the line cord through the #2 grommet from the outside. Tie a figure 8 knot about 2-1/2" from the end. Separate the conductors and strip the ends back about 3/8". Connect one end to the upper lug on ac outlet #1 and the other end to the lower lug on ac outlet #1. Solder both these connections. Pull the line cord back until the knot pulls tight against the grommet.
- () 44. Insert the 12AX7 tubes in the tube sockets on the printed circuit board. Support the board with your finger behind the socket on this first insertion so there will not be undue pressure against the board. After the sockets have been used once or twice, this is no longer necessary.
- () 45. Insert pilot lamp in the pilot lamp socket.
- () 46. Turn the chassis over and shake out all loose wire cuttings and bits of solder. Then inspect carefully to see that all connections between wires and lugs or terminals are soldered. Then see that capacitors which are mounted on the switch are turned in such a way that they do not protrude beyond the side or top of the chassis. Check to see that no other parts or wires will obstruct the cover. After this the cover can be placed over the chassis so that its flanges go outside the rear of the chassis, and it pulls forward to make a snug closure. The cover and front face of the chassis make a butt joint. Secure cover to chassis with 4 sheet metal screws.
- () 47. Unwrap the brass escutcheon plate, insert small plastic pilot light indicator, and secure with spring nut. Use pliers to open spring nut, then slip it over body of plastic indicator. Put escutcheon over the control shafts. Use 2 additional mounting nuts over selector switch and volume control shafts to secure escutcheon in place. These nuts can be tightened with finger pressure only in order to make future removal of the escutcheon easy.
- () 48. Place knob on selector switch shaft so that set screw seats against flat portion of shaft. Rotate bass, treble, and volume control shafts fully counter-clockwise and place knobs on shafts so pointer is at position corresponding to 7 o'clock. Tighten set screws. Set pointer of bass and treble controls to vertical position which indicates "flat" frequency response.
- () 49. The gold foil label which identifies the back panel connections should be held face down and flat against the table top and the paper backing peeled away from it. Place label on the back panel mid-section, centering it before smoothing it into place.

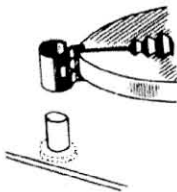

USING YOUR DYNAKIT PREAMPLIFIER

Your Dynakit preamplifier has been designed to give you longtime performance, ease of operation, and flexibility to handle all control requirements of both simple and elaborate hi fi systems. It serves as the central point of the entire system to which everything else connects.

On the rear of the Dynakit are all of the input and output connections. The low level phono input is used for magnetic phono pickups such as the Dynaco-B & O, GE, Fairchild, etc., which have less than 15 millivolts output. The high level phono input is for pickups which have greater than 15 millivolt output. These inputs should not both be connected at the same time. The high level input is part of the low level input and serves to attenuate stronger signals so as to permit the user to have more nearly equal signal levels throughout the various input channels (most equipment other than phono has its own device for adjusting levels to keep the signals from the various program sources approximately the same).

A capacitance pickup like the Weathers can be used into either phono input directly since these units are now equipped with a magnetic phono output connection.

Your radio tuner should be connected through the "radio" input, tape recorder through the "tape" input, and other high level signal sources such as crystal pickup, TV sound, etc., should be connected to the "TV" input. The "Special" input generally serves as an auxiliary magnetic phono input (for a record changer if a turntable is already being used for the regular phono input), or there is the option of using this for a tape head (for a tape deck which does not have its own preamp) or a microphone input.

There are two output connections. One of these permits connection to a tape recorder so that signals in the preamp can be fed to the recorder without being affected by the volume and tone controls of the preamplifier. Thus, when listening to radio or phonograph, it is practical to switch in the tape recorder and record the program while listening to it through the high fidelity system. The lead from the tape output should not be more than 6 feet long unless the input source is low impedance. The other output is the one which connects to the power amplifier and carries the audio signal to it. The shielded cable with plugs which is supplied with the Dynakit is ideal for this, but a longer cable can be used (up to 25 feet) if desired.

Also on the rear panel are four ac convenience outlets, two of which are always energized when the preamp is plugged in, and two of which are switched on when the preamp is turned on. The amplifier and tuner can be connected to the switched outlets. Other components like record player and tape recorder generally require a mechanical switch-off as well as an electrical one so they should not be switched off remotely but with their own switch. These, therefore, are connected to the unswitched ac receptacles.

The two cables from the back of the unit are for ac power to the entire hi fi system and for power for the tubes and circuitry of the preamp. The ac cord can be plugged into any voltage or power line frequency that can operate the other components in the system. If the amplifier requires 230 volts, 50 cps, for example, the preamp can be plugged into the same power source. The reason for this is that the ac connections on the preamp do not affect the voltages in the preamp - they are solely for the convenience of furnishing ac power and switching for other units of the system.

The power cable from the preamplifier terminates in an octal plug. This must be inserted in a separate power supply like the Dynakit PS-1, or in the properly wired octal socket of an amplifier from which the required power is to be drawn. The wiring for this socket so as to use a Dynakit Mark II amplifier as the power source is shown on the pictorial wiring diagram. The Dynakit Mark III includes these connections in the general wiring instructions for the unit. Practically any power amplifier can be used to furnish the necessary voltages for the preamplifier since the voltage requirements are very modest. The necessary voltages are 6 volts ac at .75 amps, between 200 and 400 volts dc at 3 to 4 ma, and a common ground connection. These are connected to the power socket as follows:

Pins #1 and #2 are used for the 6 volt ac connection. This should be taken from the heater supply in the amplifier by connecting 2 wires directly to the heater pins of one of the tube sockets, twisting these together and connecting them to pins #1 and #2 of the preamp power socket. This heater circuit should be "floating" which means that neither the centertap nor any portion of it should be grounded or else there may be excessive hum. This 6 volt ac connection is converted to 11 volts dc through a voltage doubler arrangement in the preamplifier.

Pin #5 is used for the B+ connection for a dc voltage between 200 and 400 volts. It is desirable to take this connection from a point in the amplifier which has had some power supply filtering, and a resistor of at least 10,000 ohms (1 watt) rating should be used between pin #5 and the voltage source to obtain additional filtering for the preamplifier. The optimum voltage at pin #5 after connection of the preamplifier is 350 volts. However, the performance specifications of the unit will be met over the range of 200 to 400 volts.

Pin #3 should be used for a ground connection between preamplifier and amplifier chassis. As shown in the diagram for connecting the preamplifier to a Dynakit Mark II, this connection should preferably be made through a small resistor of about 10 ohm value between pin #3 and chassis. This eliminates the possibility of hum induced by a ground loop which could occur with a common ground in both audio and power cables.

Ampifiers which require a shunt across pin #6 and #7 in order to switch them on (this is true for Heath-

kit amplifiers) are automatically accommodated by the power plug of the Dynakit preamplifier which contains a jumper between these two pins. This makes it practical to use the preamplifier with these amplifiers without circuit modifications.

The front panel contains all the operating controls. The selector switch selects the various inputs, and gives a choice of LP, 78 rpm, or RIAA phono equalization when selecting the phono input. These three characteristics will handle all recent recordings and most recordings from the period more than five years ago. The "Special" input can serve either as an additional phono input or for microphone or tape head. Note that its use for tape head is only required when the tape deck has no preamplifier. If the tape head has its own preamplifier the output from it should be put in the "Tape" input which is selected by the "Monitor" switch.

The "monitor" slide switch selects either the input from the tape recorder or the input to which the selector switch is set. This permits comparing the input signal to the output of the tape recorder without disturbing the recording process if the tape recorder has a monitor head. When not playing a tape recorder, this switch should always be left on "input" or else the various inputs are not fed through the preamplifier.

The bass and treble controls are of the type in which the center setting gives flat response without frequency discrimination. These increase or decrease the signal level at frequency extremes depending on whether they are rotated clockwise or counter-clockwise. Normal "flat" use of these controls is in the center position with variation made to correct the tonal balance to please the taste of the listener. It is recommended that these should be left centered and adjustments made with reference to the flat setting rather than having the user fall into the habit of keeping a setting which offers a large amount of tonal correction all the time. The reference point should always be the center setting which gives no frequency discrimination.

The volume control also acts as an on-off switch, going "on" as soon as rotated from its most counter-clockwise position. Its normal position of operation will be in the range from "9 o'clock" to "2 o'clock." The overall sensitivity and gain of the preamplifier is such that the volume control is in the proper range with amplifiers requiring from one to two volts for full output. Amplifiers of greater sensitivity than this normally have means for adjusting their sensitivity by means of an input level control. In that case the amplifier's control should be set to give fairly loud level when the preamp's volume control is at "12 o'clock." Amplifiers of lower sensitivity, requiring two volts or more for full output, cannot be driven to full output from the Dynakit preamplifier with low level signal sources. For example, a magnetic cartridge like the Fairchild 215 has an average output of 3 millivolts. This signal level will produce 1.5 volts output from the preamplifier. This is sufficient to drive a Dynakit amplifier to full output. Amplifiers of less sensitivity (of which there are very few) will not give full out-

put from this signal source. However, with a cartridge which furnishes 10 millivolts output, the Dynakit preamplifier will give up to 5 volts output. This is more than enough for any amplifier on the market.

The "loudness" slide switch on the front panel introduces loudness correction when the volume control is below its mid settings. This correction involves an increase in level of the bass below 400 cps and the treble above 3000 cps. This correction is used because the ear is not as sensitive to extreme frequencies at low levels as at high levels. When music is played softly, it sounds thinner because of this effect, as if the listener sat further away from the original sound source. Loudness compensation helps to move the listener back to the front of the concert hall. The switch permits introducing or eliminating the correction. When the loudness is "on", the corrective effect is diminished when the volume is increased and signal levels are louder, and vice versa. When the switch is "off", there is no frequency discrimination in the volume control circuit. The high fidelity "purist" will not use this frequency discrimination, but most musical listeners will find that it adds to the enjoyment of low level music and background music. The effect is restricted in the Dynakit preamplifier so that it can be used without obvious distortion of the tonal balance. This type of subtle correction does not add boom or muddy quality to the reproduction.

* * *

Now that the function of the various sockets, controls, and switches has been explained it is time to use the preamplifier. The various input plugs should not be inserted until all of the above functions are understood. Then they can be inserted, and the ac plugs can be inserted. The power cable can go to the amplifier or power supply which is being used, and the audio output cable can go to the amplifier. At this point it should be mentioned that practically all amplifiers have an input impedance of 470,000 ohms (nominally 500,000) or more. The preamplifier is designed to work with this type of input impedance. However, there are a few amplifiers with input filter networks which reduce their impedance to 250,000 ohms. This is also the impedance which is obtained when putting two amplifier inputs in parallel for double output capability. In this case there is provision in the Dynakit to make it operate properly with this lower input impedance.

This change is made by snipping out the 510,000 ohm (green-brown-yellow) resistor which is connected from lug terminal #2 to lug terminal #3. Fortunately, this is rarely necessary.

After all cables have been connected, the unit can be turned on without advancing the volume control. Then with the selector switch on "78" and with the bass and treble controls centered, monitor on "input," loudness "off" the volume can be advanced until noise is heard. The hum balance control should be rotated until the hum component of this noise is minimized. Then the volume should be reduced to the minimum and a listening test for noise made with the ear near the speaker. If hum is

heard, the preamplifier should be turned off and its audio cable removed from the amplifier. Then the unit should be turned on again to check the amplifier alone. If noise still persists it is obviously in the amplifier rather than the preamplifier, and the amplifier should be checked for this.

If the noise enters the picture only when the preamp is connected, the ac plug of the preamp should be reversed in the socket. If this does not reduce the noise, each input plug should be removed in turn. If removal of one of the input plugs improves the condition, the ac plug for the equipment used in that input should be inverted which should cure the trouble.

Continued noise after the above expedients will require trouble shooting in the equipment as it indicates something defective or misconnected.

Normally, there should be no audible hum and only the slightest trace of hiss if the volume control is turned down and the ear is placed near the speaker. If the control is advanced while on phono input, the hiss level will increase slightly at high settings of the volume control. Hum should be almost inaudible at full volume unless it is induced in the phono pickup. This can be checked by disconnecting the phono plug from the preamp and then turning up the volume to see if it is quiet. For elimination of hum induced in the pickup, the recommendations of the pickup manufacturer should be followed, and the turntable may have to be grounded in accordance with its manufacturer's suggestions. Proper use of the hum balance control should almost completely eliminate all hum within the preamp. If it does not, the location of the preamp relative to other equipment should be shifted to see if there is an increase of noise level by proximity. If this does not help, it will be necessary to do some trouble shooting.

Now that everything is ready you can play records or tape or listen to your radio tuner, and your reproduction should give crystal clarity with almost complete absence of background noise. If you should hear some hiss from your records, turn the treble control counterclockwise until the noise is not disturbing. If your turntable seems to give some rumble, this can be reduced by slight use of the bass control. These controls have been designed to enhance your listening pleasure. They correct deficiencies in your program material without increasing the distortion of the system. Their action is at the ends of the frequency band where the effect on the middle frequencies is slight.

Note that when you switch the slide switches or the selector switch, there are no heavy plops or bangs. Also, you can leave the radio tuner on while playing records since there is no cross-talk between channels and none of the sound from one will leak over to the next. All in all you should have a smooth sounding, smooth operating unit which will continue to operate for many years without difficulty. However, if you run into operating difficulties, the suggestions in the next section will help to clear them up.

IN CASE OF TROUBLE

Although your Dynakit preamplifier has been made as trouble free as possible, there is always the possibility that a mistake in assembly or a defective part will prevent it from functioning properly. Therefore if any difficulties are encountered, the following routine should be established.

Check the wiring carefully, making sure that all connections are made and soldered, that adjacent parts are not touching, and that no pieces of solder or wire clippings have gone across adjacent points, causing shorts.

Make sure that tube filaments are lit. These do not light brightly but should be visible under dim light conditions. If tubes are unlit this indicates either a break in the power cable, a fault in the rectifier, or an open filament in the tubes. However if the pilot light works, this indicates that the power cable is functioning and this can be eliminated (at least for the heater winding) as a source of trouble.

Another test which can be made without instruments is to try feeding a signal into the radio input from a tuner or other source known to be in functioning condition. Switch to radio input when making this test. Then the two 12AX7 tubes should be interchanged and the test tried again. If signal comes through in one case and not with the tubes interchanged, it indicates a defective tube. If signals come through the radio input satisfactorily, but not through the phono input, at least the trouble has been localized to the phono section alone. A similar test to see whether or not the phono section is functioning while the tone control circuits are inoperative is to feed a signal into the phonograph input (this can be a signal from any source, although a high level source such as a tuner will not sound good because of improper equalization and overloading), and take output from the tape output socket which precedes the tone control section of the preamplifier. However, in making this test there is no control of the volume of the signal and it may possibly cause overload signals to go through the amplifier. This test should not be made unless a finger is kept on the amplifier switch so it can be turned off immediately if the sound level gets too high.

If the above tests permit isolating the fault to one or the other section of the preamplifier, then that section of course should be carefully checked. Any other type of service work which can be done, should have the use of test equipment of which the minimum item should be a high grade voltmeter, preferable a vacuum tube voltmeter or a 20,000 ohms per volt meter.

Voltage measurements should be made and compared with the enclosed voltage chart. Deviations of greater than 10% from these voltages may be an indication of malfunctioning, although deviations as high as 50% will not cause complete lack of sound.

In the event that the preamplifier is functioning, but that sound is distorted, or the noise level is high, a

check should be made of the wiring and of the voltages. Any serious discrepancy in voltage may indicate an open or shorted resistor which can only be checked by measurement of the component. Excessive noise must be separated as to whether it is hum or hiss. Hum is a completely different type of problem than hiss, and proper trouble shooting must separate one of these disturbances from the other.

Hum is generally because of poor grounding in the preamplifier or associated equipment or in a defect in the heater voltage doubler circuit. Hiss is almost invariably due to a noisy resistor, and the most common culprits are the plate and cathode resistors in the first stages. There should be practically no hiss when the preamp is switched on radio position. If there is, the 470,000 ohm plate resistor or the 4700 ohm cathode resistor of the 12AX7 are most likely to be at fault. These should be substituted with corresponding values of half watt resistor. If the hiss comes from the phono section, (noise in the phono section will be affected by settings of the volume control while noise in the tone control section is independent of volume settings; this identifies the portion of the circuit in which the noise originates) it is most likely due to either the 270,000 ohm plate resistor or 2200 ohm cathode resistor of the 12AX7. These should be removed (without damaging them) and replaced with similar resistors to see whether it cures the trouble. If not, reinstate the original resistors which are of a type which should produce very low noise.

Please note that when the cover is not on the preamplifier, the hum level will be many times higher than when the cover is on and properly closed with the sheet metal screws. Therefore, testing should be done only with the cover secured in place.

FACTORY SERVICE AND GUARANTY

All parts in the Dynakit are guaranteed for a period of one year, except for tubes which carry the standard EIA guarantee of 90 days, and defective components will be replaced without charge if returned to the factory directly or via your dealer. Many dealers carry Dynakit spare parts in stock to facilitate replacements. After the guarantee period, parts are charged for at regular net prices.

In the event that the assembled kit does not function properly or breaks down after some use, Dyna Company will service the kit for a service fee of \$5.00 plus the cost of parts which have been damaged by the user or are past the guarantee period. This service facility is not available for kits which are incompletely wired, or have been wired with other than rosin core solder, or in which changes have been made without factory authorization. In addition, NO PARTS WILL BE REPLACED NOR WILL ANY SERVICE BE AVAILABLE FOR KITS WHERE THE GUARANTEE POST CARD HAS NOT BEEN RETURNED. THE SERIAL NUMBER ON THIS INSTRUCTION BOOK MUST BE MENTIONED IN CORRESPONDENCE, PARTS

RETURN, OR KITS RETURNED FOR FACTORY SERVICE. It is the factory prerogative to limit the service facility to one year from date of purchase.

When shipping the preamplifier for service a note must be attached specifying the symptoms, the name and address of the sender, and the serial number. The kit should be securely packed in a carton in which it is surrounded by several inches of shredded paper or other soft packing material. Shipment should be made by prepaid Railway Express, where possible; and repaired kits will be returned by Railway Express collect. Parcel post is not a safe method of shipment for completed kits and should not be used.

Dyna Company assumes no responsibility or liability for damages or injuries sustained in assembly or operation of the Dynakit.

VOLTAGE CHECK POINTS

The dc voltages below were measured with a vacuum tube voltmeter. Meters of lower impedance will show lower readings on some of the measurements. Readings were made with power supplied by Dynakit Mark III, furnishing a supply voltage of 350 dc. If a supply of different voltage is used, the readings in the voltage chart will be changed, higher for supply voltages above 350 and lower for supply voltages below 350.

Pin #	V1	V2	Capacitor lug #	
1	118	160	1	310 V
2	0	0	2	260 V
3	1.1	1.8	3	350 V
6	180	200	4	325 V
7	0	0		
8	1.4	1.5		

Measure filament voltage between black lug of selenium rectifier (negative probe) and red lug of rectifier (positive probe). . . 11 volts.

DYNAKIT PREAMPLIFIER PARTS LIST

(Parts of similar type which do not change performance may sometimes be included as a matter of expediency).

- | | |
|--|---|
| 1 - Chassis Assembly (including cover) | 1 - Selector Switch |
| 1 - Bracket | 1 - 1K (1,000) ohm control |
| 1 - Line Cord | 1 - 400K (400,000) ohm control |
| 1 - Cable-4 conductor | 1 - 750K (750,000) ohm control |
| 1 - Shielded cable | 1 - 500K (500,000) ohm control |
| 2 - Slide switch-spdt | 1 - 250 mmfd (or pf) precision capacitor |
| 1 - Lug terminal | 1 - 750 mmfd (or pf) precision capacitor |
| 1 - Escutcheon plate | 1 - 1000 mmfd (or pf) precision capacitor |
| 1 - Hook-up wire | 1 - 3200 mmfd (or pf) precision capacitor |
| 4 - Knobs | 1 - .5 mfd capacitor |
| 4 - AC receptacles | 2 - .1 mfd capacitor |
| 1 - Wafer for quad electrolytic | 1 - .02 mfd capacitor |
| 1 - Lamp bracket | 1 - .05 mfd capacitor |
| 1 - #47 lamp | 1 - .002 mfd capacitor |
| 1 - Pilot light indicator and spring nut | 2 - .0075 mfd capacitor (matched) |
| 1 - Octal plug and cap | 1 - Quad electrolytic |
| 1 - Selenium rectifier | 2 - 1000 mfd capacitor |
| 8 - Phono input sockets | 1 - 33 mmfd capacitor |
| 1 - Piece sleeving | 1 - 100 mmfd capacitor |
| 2 - Grommets | 2 - 12AX7/ECC-83 tubes |
| 4 - Rubber feet | RESISTORS |
| 7 - Control nuts | 1 - 47,000 ohm (yellow-purple-orange) |
| 5 - Control lockwashers | 1 - 62,000 ohm (blue-red-orange) |
| 37- #4 x 1/4" Machine screws | 1 - 510,000 ohm (green-brown-yellow) |
| 33- #4 nuts | 1 - 1,000 ohm (brown-black-red) |
| 33- #4 lockwashers | 2 - 10,000 ohm (brown-black-orange) |
| 1 - #6 x 2" Machine screw | 1 - 56,000 ohm (green-blue-orange) |
| 2 - #6 nuts | 1 - 100,000 ohm (brown-black-yellow) |
| 2 - #6 lockwashers | 1 - 330,000 ohm (orange-orange-yellow) |
| 4 - #6 sheet metal screws | 1 - 470,000 ohm (yellow-purple-yellow) |
| 1 - Printed circuit assembly | 1 - 560,000 ohm (green-blue-yellow) |
| 1 - Set instructions w/label & warranty card | 1 - 1.5 megohm (brown-green-green) |

SPECIFICATIONS

Inputs: Low level magnetic cartridge, high level magnetic, radio, TV, tape, special optional low level.

Outputs: Tape, audio output.

Controls: Selector and equalization, bass, treble, volume, tape monitor, loudness, and hum balance.

Tone Control Range: ± 14 db at 20,000 cps. ± 20 db at 20 cps.

Phono Equalization: RIAA, 78 rpm, original LP.

Distortion: Less than .1% intermodulation at sufficient output to drive all power amplifiers. This figure unchanged at any setting of volume control.

Response: $\pm .5$ db 6 cps to 60 kc if tone controls accurately zeroed. Response not affected by position of volume control.

Transient Performance: Passes square waves without deformation or ringing from 20 cps to 20 kc at any volume control setting. No overshoot or bounce on pulse type signals. Instantaneous recovery from overload.

Noise: Less than 3 microvolt equivalent noise input on RIAA. Less than 1.5 microvolt equivalent on mike connection. Between 70 and 74 db below level of 10 millivolt magnetic cartridge.

Gain: 54 db at 1000 cps on RIAA input. 20 db 20 cps to 20 kc on high level inputs.

Impedances: Output impedance 1000 ohms. Terminating impedance 500,000 ohms (provision for 250,000 ohms).

Tubes: 2 12AX7 (ECC-83), 1 selenium stack.

Power Requirements: 200 to 400 volts dc at 3 to 4 ma, 6 volts ac at .75 amps.

ACCESSORIES

- PS-1 dual power supply
- PM-1 panel mount kit
- DSC-1 stereo control.

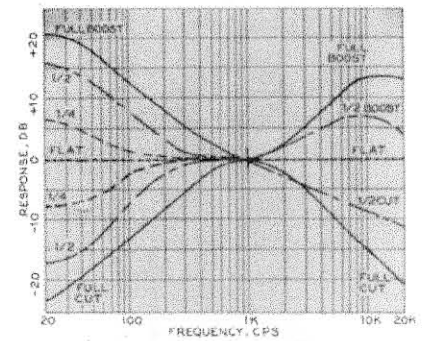

Fig. 7. Contours of the tone controls.

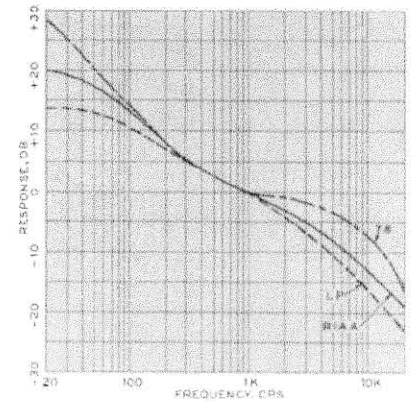

Fig. 8. Equalization of phono channel.

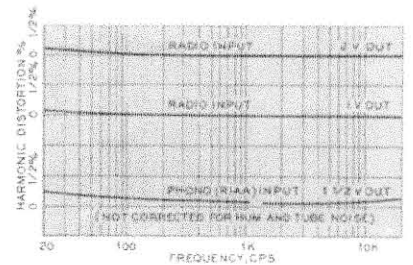

Fig. 9. Harmonic-distortion percentage.

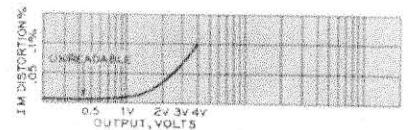

Fig. 10. Curve indicates IM distortion.

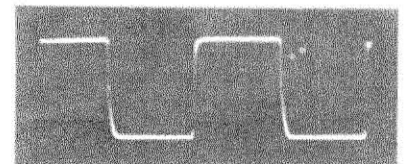
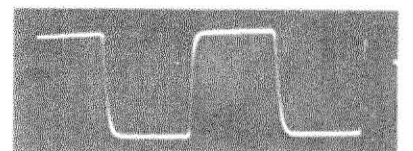
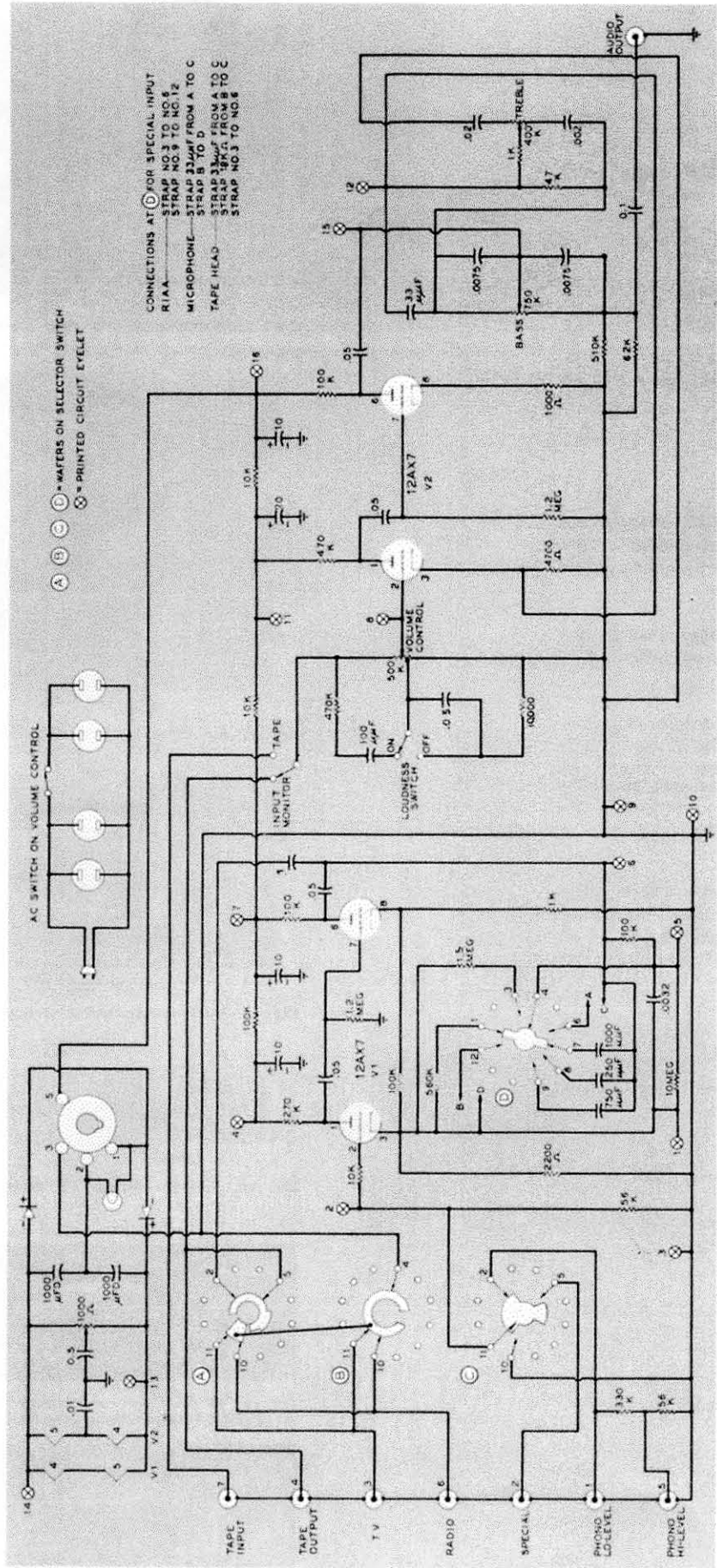

Fig. 11. 10 KC square wave from Dyna-kit (below) is much like original (above).





DYNAKIT PREAMPLIFIER CIRCUIT

Bob01605@aol.com

CONNECTIONS FOR DYNAKIT MARK II
PREAMPLIFIER POWER SOCKET

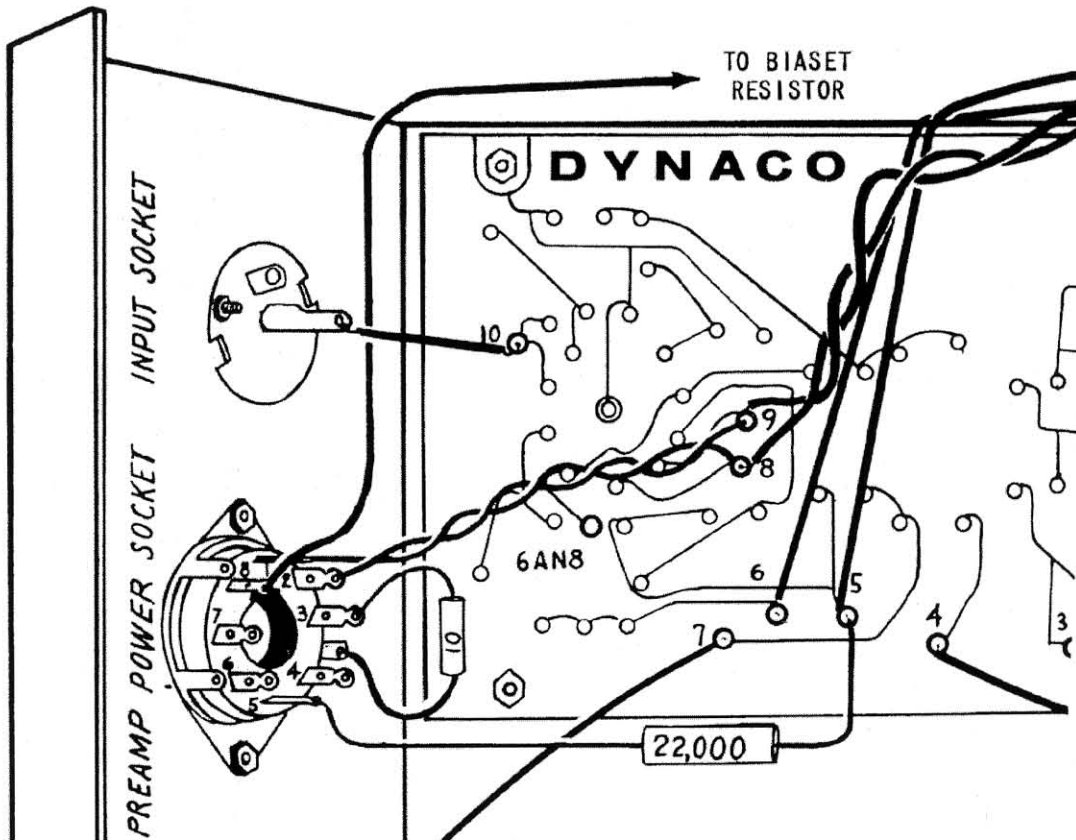

1. Add twisted pair of short wires from eyelets #8 (S) and #9 (S) on printed circuit board to pins #1 (S) and #2 (S) on power socket.
2. Connect 22,000 ohm (1 watt) resistor from eyelet #5 (S) to pin #5 (S) on power socket.
3. Connect 10 ohm (1/2 watt) resistor from pin #3 (S) to ground lug (S) on side of socket.
4. Cut jumper between terminals #2 and #3 on lug terminal strip (not shown on above drawing).

Bob01605@aol.com

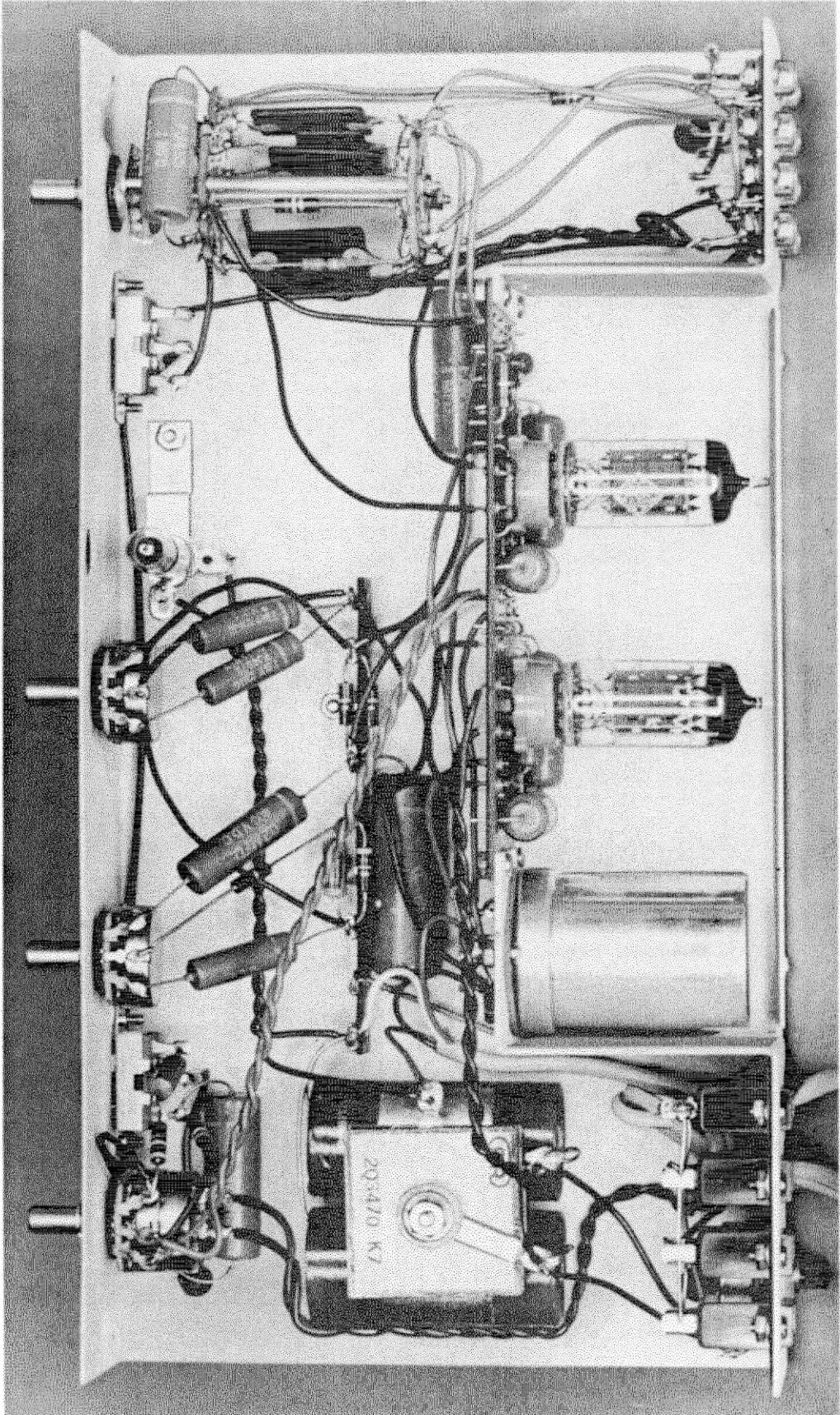

Bob01605@aol.com